

MP160 SYSTEMS

AVAILABLE MP160 STARTER SYSTEMS

MP160 Licensed Systems . See corresponding license page for more information:

System	Windows Part #	Mac Part #
MP160	MP160WSW	MP160WS
MP160 plus Scripting	MP160WSW-BAS	MP160WS-BAS
MP160 plus Network Data Transfer	MP160WSW-NDT	MP160WS-NDT
MP160 plus Pressure Volume Loop Analysis	MP160WSW-PVL	MP160WS-PVL
MP160 plus Developer Bundle	MP160WSW-ENT	N/A
MP160 plus 2-channel Vibromyography	VMG102WSW	VMG102WS
MP160 plus 4-channel Vibromyography	VMG104WSW	VMG104WS
MP160 System plus Baroreflex	MP160WSW-BRS	MP160WS-BRS
MP160 System plus Actigraphy	MP160WSW-ACT	MP160WS-ACT
System Upgrade . MP150 to MP160	MP160U-W	MP160U-M

MP160 data acquisition and analysis systems with *AcqKnowledge 5* software provide a flexible tool for life science research. All systems are compliant with any Ethernet (UDP) ready 64-bit computer running Windows or Mac (*AcqKnowledge 5* or higher required). Record multiple data channels with variable sample rates to maximize storage efficiency at speeds up to 400 kHz (aggregate). Directly connect the computer to a single MP160 unit via the provided ETHUSB Ethernet adapter, or access multiple MP160s by connecting a switch box to the adapter*.

Basic MP160 System includes:

- Data acquisition unit: MP160
- High level transducer module: HLT100C
- AcqKnowledge*® software license and installer USB keys
- Software Guide (PDF)
- Ethernet Connection
- ETHUSB Ethernet adapter and Ethernet Cable: CBLETH1
- Power Supply: AC150A



See also: [MP160 Specifications](#)

Recommended MP160 configuration

*For the best possible performance connect the MP System directly to the ETHUSB Ethernet USB adapter using the included CBLETH1 Ethernet cable. This allows uninterrupted use of the existing Ethernet card for Internet and local area network (LAN) access while using the MP System. Although it is possible to run multiple MP160 units over a LAN, this solution is not recommended by BIOPAC. BIOPAC recommends using the ETHUSB adapter and connecting directly between computer and the MP160, or to a switch box and the MP160. (If a computer does not require simultaneous connection to the network, a standard Ethernet cable can be used to connect the MP System to a computer.)

➡ Click to view the [MP160 System Diagram with BIOPAC Amplifier](#).

MP160 SYSTEM SPECIFICATIONS

Analog Inputs

Number of Channels: 16
 Absolute Maximum Input: ±15 V
 Operational Input Voltage: ±10 V
 A/D Resolution: 16 Bits
 Accuracy (% of FSR): ±0.003
 Input impedance: 1.0 MΩ

Application Programming Interfaces options:

- Hardware Interface BHAPI
- Software Interface ACKAPI

Analog Outputs

Number of Channels: 2
 Max output with acquisition: 2 channels
 Output Voltage Range: ±10 V
 D/A Resolution: 16 bits
 Accuracy (% of FSR): ±0.003
 Output Drive Current: ±5 mA (max)
 Output Impedance: 100 Ω

Digital I/O

Number of Channels: 16
 Voltage Levels: TTL, CMOS
 Digital I/O Logic Type: CMOS
 Input Voltage Range: -0.5 V to 5.5 V (max)
 Input Clamp Current: ±20 mA (max)
 Output Drive Current: ±20 mA (max)
 External Trigger Input: TTL, CMOS compatible - See also: [External Trigger Inputs](#)
Logic Level Thresholds:
 Input Low Voltage: 1.50 V (max)
 Input High Voltage: 3.45 V (min)

Time Base

Min Sample Rate: 2 samples/hour
 Trigger Options: Internal, External or Signal Level

Power

Amplifier Module Isolation: Provided by the MP unit, isolated clean power
 CE Marking: EC Low Voltage and EMC Directives
 Leakage current: <8 μA (Normal), <400 μA (Single Fault)
 Fuse: 2 A (fast blow)

Device specs	MP160
Max Sample Rate	200 K samples/sec (400 K aggregate)
MP Internal Memory:	
PC Memory/Disk:	200 K samples/sec (400 K aggregate)
Internal Buffer:	6 M samples

Device specs	MP160
Waveform Output Buffer:	500 K samples
Serial Interface Type/Rate:	Ethernet: UDP (10M bits/sec)
Transmission Type:	Ethernet
Maximum cable length:	100 meters (Ethernet cable)
Power Requirements:	12 VDC @ 2 amp (uses AC150A)
Dimensions:	10 cm x 11 cm x 19 cm
Weight:	1.0 kg
Operating Temperature Range:	0-70° C
Operating Humidity Range:	0-95%
Software Compatibility:	AcqKnowledge 5 and higher only (MP160 is not compatible with earlier AcqKnowledge versions)
OS Compatibility	
Ethernet Interface	
Windows	Windows 7, 8.x, 10
Mac	OS X 10.10, 10.11
USB Interface	
Windows	Not supported
Mac	Not supported

ISOLATION

Designed to satisfy the following Medical Safety Test Standards affiliated with IEC 60601-1:

- Creepage and Air Clearance
- Dielectric Strength
- Patient Leakage Current

Contact BIOPAC for additional details.

SIGNAL CONDITIONING MODULE COMPATIBILITY

CO ₂ 100C	EGG100C	HLT100C	PPG100C
DA100C	EMG100C	LDF100C	RSP100C
EBI100C	EOG100C	MCE100C	SKT100C
ECG100C	ERS100C	O ₂ 100C	STM100C
EEG100C	GSR100C	OXY100C/E	TEL100C

MP160 also interfaces with [BioNomadix Series Wireless Modules](#).



CLEANING PROCEDURES

Be sure to unplug the power supply from the MP160 before cleaning. To clean the MP160, use a damp, soft cloth. Abrasive cleaners are not recommended as they might damage the housing. Do not immerse the MP160 or any of its components, as this can damage the system. Let the unit air-dry until it is safe to reconnect the power supply.

AC150A POWER SUPPLIES

The 12-volt in-line switching transformer connects the MP unit to the AC mains wall outlet. One transformer is included with each MP System; replacements can be ordered separately. These transformers are specified to satisfy IEC 60601-1 requirements and will accommodate 120-240 VAC (50/60 Hz) mains input.

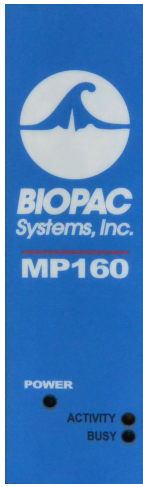
MP160 SYMBOLOGY

Front panel	See “Light Status” section for functionality details.
	<p>POWER Green light Indicates MP160 Power status.</p> <p>ACTIVITY Amber light Indicates data traffic to or from MP160 <i>similar to Hard Disk activity light on any personal computer.</i></p> <p>BUSY Green light Indicates MP160 data acquisition.</p>
Back panel	
	<p>Power ON Push in to power up the MP160 OFF Pop out to cut the flow of power to the MP160</p> <p style="background-color: yellow;">IMPORTANT! The MP160 does not have a “Hardware Reset” switch like a personal computer does. To reset the MP160 for any reason, turn the MP160 off, wait a few seconds, and then turn it back on.</p> <p>Fuse 2A 2 Amp fast-blow fuse holder; the maximum capacity of the fuse is 2 Amps. <ul style="list-style-type: none"> ▪ To remove the fuse, use a screwdriver to remove the fuse cover, which is located below the word Fuse. </p> <p>DC Input Use the DC Input to connect a battery, AC/DC converter or other power supply to the MP160. <ul style="list-style-type: none"> ▪ The MP160 requires 12 VDC @ 1 Amp (minimum), 2 Amp (nominal) ▪ The receptacle can accept a ð+ö (positive) input in the center of the connector and a ð-ö (negative) input on the connector housing. </p> <p>Ethernet The MP160 connects to the computer via the Ethernet port, located just to the right of the word Ethernet. <ul style="list-style-type: none"> ▪ Uses a standard RJ-Ethernet connector (10 base T). </p>
Side panel	
<p>Module connections</p>	<p>The two connector inputs are designed to connect directly to the HLT100C.</p> <ul style="list-style-type: none"> ▪ Analog signals are transmitted through the 37-pin connector (upper right side) ▪ Digital signals are transmitted through the 25-pin connector (lower-right side)

ACTIVITY BUSY	MODE	LIGHT STATUS DESCRIPTION
A Bright B Bright	Self-Test	ACTIVITY and BUSY be bright for the duration of the self-test and setup process. This may take 3 6 10 seconds, depending on MP160 internal memory.
	Work	During data acquisition, ACTIVITY reflects command/data traffic (for acquisition speeds of 1000 Hz or more, ACTIVITY will be permanently bright or blink at a high frequency) and BUSY will be bright. It is normal for both lights to be onô this does not indicate a problem unless an Error Message is generated on the computer screen.
	Error	ERROR: In rare cases, a serious problem may prevent a self-test and the lights may be erratic: both on, both off, or any other static combination.
A Bright B Blink	Error	The MP160 enters the Error Mode if a fatal error occurs during the Self-test Mode. In the Error Mode, ACTIVITY is bright and BUSY is blinking at a frequency of 5 Hz.
A Blink B Bright	Error	If the self-test fails or setup fails, the Error mode is initiated and ACTIVITY will blink at about 5 Hz rate and BUSY will remain bright.
A Blink B off	Idle-1	ACTIVITY <u>blinks twice</u> with approximately 1.5-2 second interval and BUSY is OFF. Double blink means: <ul style="list-style-type: none"> - MP160 may be disconnected from LAN or, - MP160 is connected to LAN but did not receive IP address from networkø DHCP server and default 169.254.xxx.xxx address is self-assigned to MP160. This is the standard state for MP160 connected to NIC through Ethernet network cable. It means the MP160 is in working condition and ready for acquisition. <i>AcqKnowledge</i> may communicate with the MP160 through a serial cable or through a network by using 169.254.xxx.xxx address and/or Ethernet cable.
	Idle-2	ACTIVITY <u>blinks once</u> with approximately 1.5-2 second interval and BUSY is OFF. Single blink means: <ul style="list-style-type: none"> - MP160 is connected to LAN and received IP address from networkø DHCP server. It means the MP160 is in working condition and ready for acquisition.
A off B off	Self-Test	ACTIVITY and BUSY will go dark for less than 1 second at the end of the self-test before proceeding to the Idle mode.
	Wait	Under some conditions, such as when a dialog box is open, <i>AcqKnowledge</i> cannot send commands to the MP160. When command flow from the workstation stops, the MP160 acts as if there is an open dialog and enters the Wait Mode to wait for a command from the workstation it is òlockedö toô commands from any other work station will be ignored. When it receives a command, the MP160 return to the Work mode. After five minutes with no command communication, the MP160 will revert to the Idle mode.
	Error	ERROR: In rare cases, a serious problem may prevent a self-test and the lights may be erratic: both on, both off, or a static combination.

MP160 STATUS LIGHT PATHS

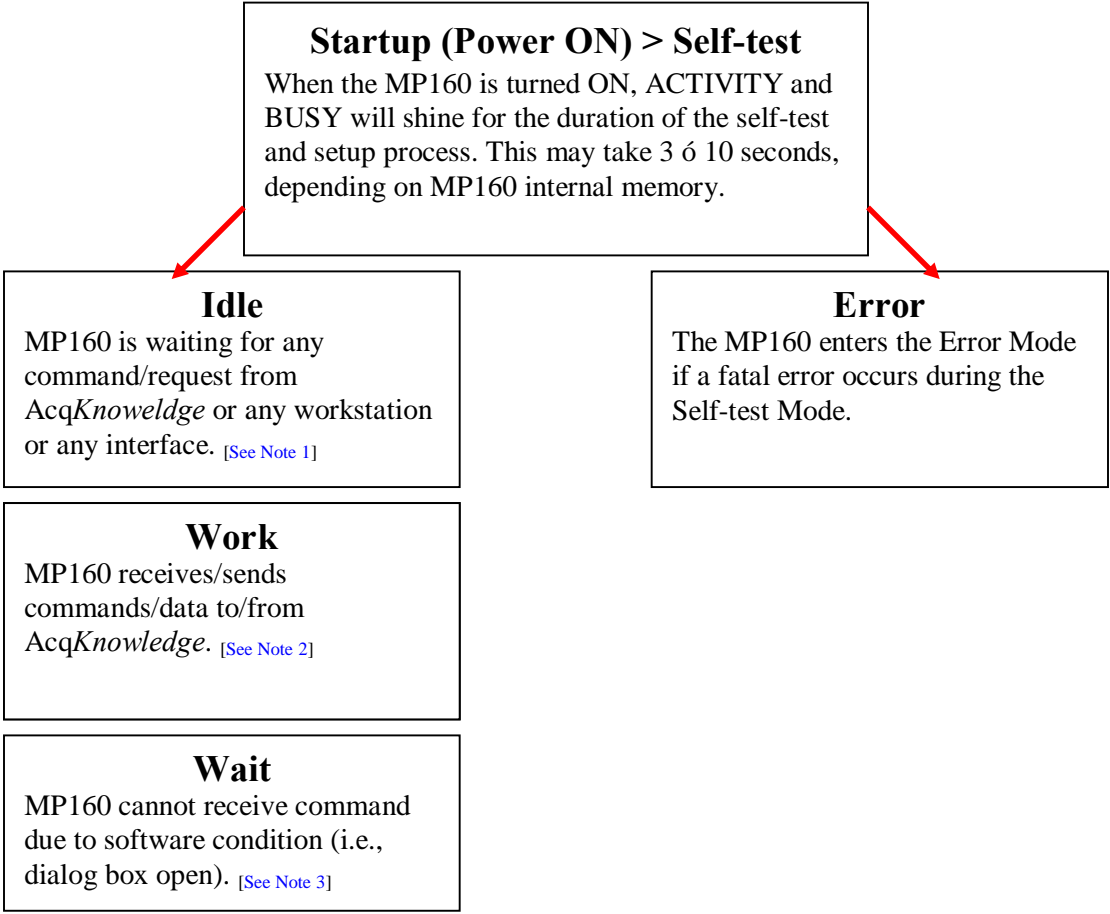

- NOTES**
1. **IDLE** Both light patterns are normal and indicate that the MP160 is waiting for a command neither indicates a problem with the MP160. The MP160 can switch between Idle-1 and Idle-2. Idle-1 or Idle-2 pattern indicates which IP address the MP160 is using:
 - Idle-1: self-assigned address in 169.254.xxx.xxx network
 - Idle-2: address from DHCP server).
 2. **WORK** When the MP160 receives any command from any workstation, it locks on to that workstation and communicates with it exclusively. The MP160 remembers the active workstation and will ignore commands from any other workstation. The MP160 usually remains in the Working Mode until the *AcqKnowledge* software program is closed.
 3. **WAIT** Under some conditions, such as when a dialog box is open, *AcqKnowledge* cannot send commands to the MP160. When command flow from the workstation stops, the MP160 acts as if there is an open dialog and enters the Wait Mode to wait for a command from the workstation it is locked to commands from any other work station will be ignored. When it receives a command, the MP160 enters the Work mode; if the MP160 does not receive a command within five minutes, it reverts to Idle.

MP160A-CE DATA ACQUISITION UNIT BLOCK DIAGRAM

The MP160 has an internal microprocessor to control the data acquisition and communication with the computer. There are 16 analog input channels, two analog output channels, 16 digital channels that can be used for either input or output, and an external trigger input. The digital lines can be programmed as either inputs or outputs and function in 8 channel blocks. Block 1 (I/O lines 0 through 7) can be programmed as either all inputs or all outputs, independently of block 2 (I/O lines 8 through 15).

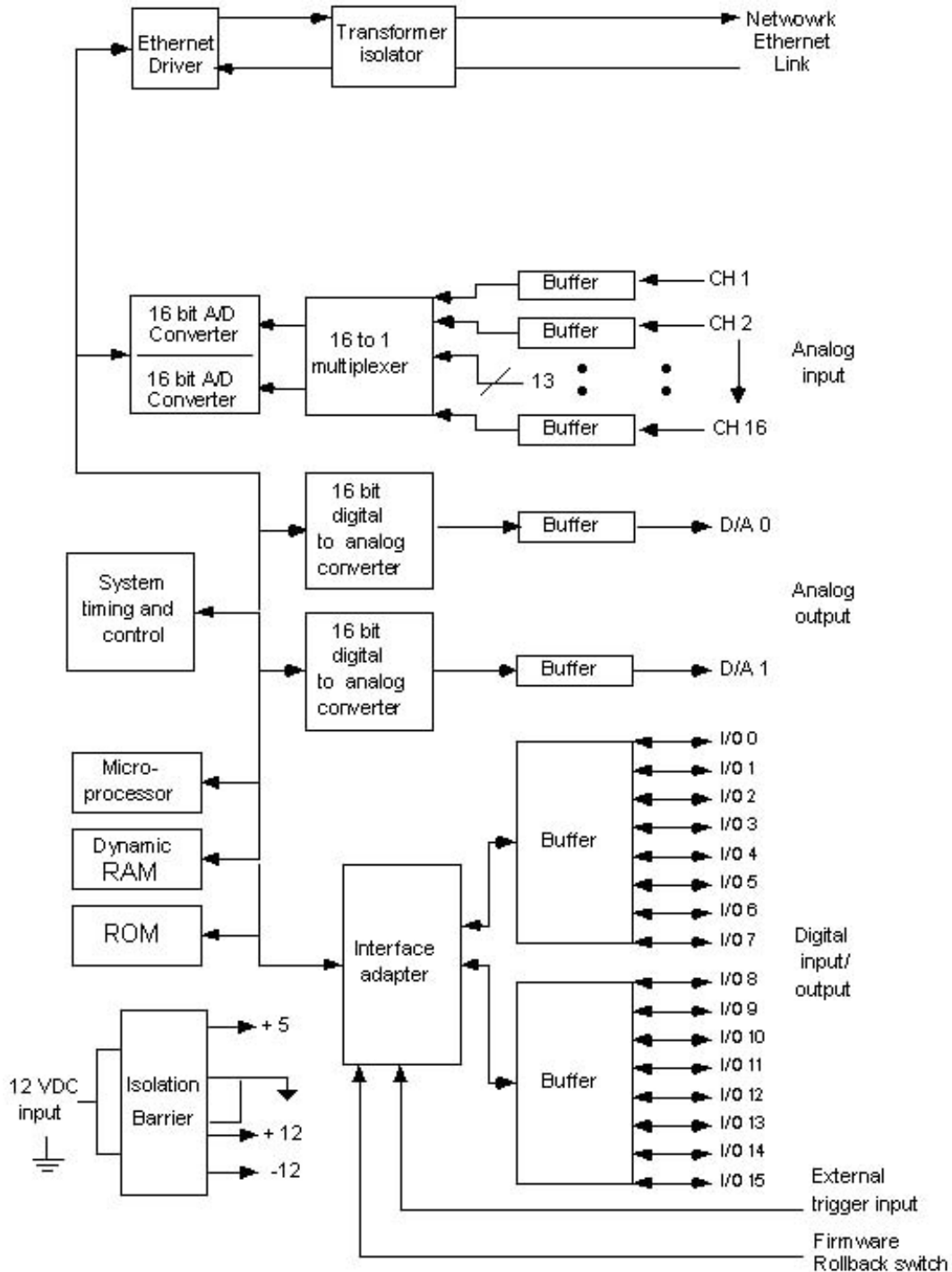

MP160A-CE block diagram

See also: MP160 Specifications

MP SYSTEM PIN-OUTS — FOR MP160

Digital DSUB 25 (male) Pin-outs

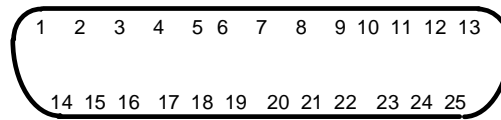

DIGITAL

Pin	Description	Pin	Description
1	I/O 0	14	I/O 4
2	I/O 1	15	I/O 5
3	I/O 2	16	I/O 6
4	I/O 3	17	I/O 7
5	GND D	18	GND A
6	GND D	19	Out 1
7	EXT T	20	Out 0
8	+5 VD	21	GND A
9	+5 VD	22	I/O 12
10	I/O 8	23	I/O 13
11	I/O 9	24	I/O 14
12	I/O 10	25	I/O 15
13	I/O 11		

Analog DSUB 37 (male) Pin-outs

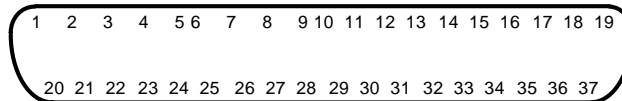

ANALOG

Pin	Description	Pin	Description
1	GND A	20	CH 1
2	GND A	21	CH 2
3	GND A	22	CH 3
4	GND A	23	CH 4
5	GND A	24	CH 5
6	GND A	25	CH 6
7	GND A	26	CH 7
8	GND A	27	CH 8
9	+12 V	28	+12 V
10	GND A	29	- 12 V
11	-12 V	30	CH 9
12	GND A	31	CH 10
13	GND A	32	CH 11
14	GND A	33	CH 12
15	GND A	34	CH 13
16	GND A	35	CH 14
17	GND A	36	CH 15
18	GND A	37	CH 16
19	GND A		

ETHERNET CONNECTOR PIN-OUTS (FOR MODEL MP160 ONLY)

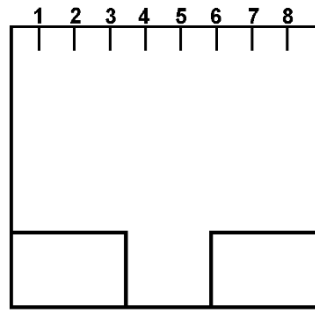

Front View

Pin	Description
1	TXD+
2	TXD-
3	RXD+
4	No Connection
5	No Connection
6	RXD-
7	No Connection
8	No Connection